

## Boost Converter with 6-CH LED Driver Evaluation Board

### **General Description**

The Evaluation Board demonstrates the RT4539A device provides a highly integrated white LED driver solution for Notebook and Tablet LCD backlight. The device is a white-LED driver featuring a 36V high efficiency asynchronous boost converter and six 35mA high precision current sinks with a maximum of  $\pm 2\%$  current mismatching for excellent brightness uniformity in each string of LEDs. The RT4539A has five dimming modes including DC mode, direct PWM mode, PWM-26k mode, mix mode and mix-26k mode that can be controlled by PWM signal or an I<sup>2</sup>C master, or both. In addition, the RT4539A has a wide input voltage operating range from 2.7V to 24V and contains I<sup>2</sup>C interface for controlling the dimming mode, operating frequency, LED current slope time and the LED current. It is suitable for single/two cell battery input to drive LED light bars which contain six strings in parallel.

## Table of Contents

General Description .....	1
Performance Sepcification Summary .....	2
Power-up Procedure .....	2
Detailed Description of Hardware .....	4
Bill of Materials.....	6
Typical Applications .....	7
Evaluation Board Layout.....	11
More Information.....	15
Important Notice for Richtek Evaluation Board.....	15

## Performance Specification Summary

Summary of the RT4539AGQW Evaluation Board performance specification is provided in Table 1. The ambient temperature is 25°C.

Table 1. RT4539AGQW Evaluation Board Performance Specification Summary

Specification	Test Conditions	Min	Typ	Max	Unit
<b>Input Voltage Range</b>		2.7	3.8	24	V
<b>Operation Frequency</b>	Boost operates at PWM mode default = 600kHz @ 0x07h	300	600	1600	kHz
<b>Switching Frequency Accuracy</b>	Boost operates at PWM mode, fsw = 600kHz	-10	--	10	%
<b>Switching Current Limitation</b>		2	2.5	3	A
<b>Maximum LED Current Setting</b>	LED 100% setting, register address = "02h", Step = 0.12mA	10.04	--	35	mA
<b>LED Current Accuracy</b>	PWM duty = 100%, I <sub>FBx</sub> = 20mA, PWM frequency = 1kHz	-3	--	3	%
	PWM duty = 5%, I <sub>FBx</sub> = 20mA, PWM frequency = 1kHz	-5	--	5	
	PWM duty = 1%, I <sub>FBx</sub> = 20mA, PWM frequency = 1kHz	-15	--	15	
<b>LED Current Matching</b>	PWM duty = 100%, I <sub>FBx</sub> = 20mA, PWM frequency = 1kHz	-2	--	2	%
	PWM duty = 5%, I <sub>FBx</sub> = 20mA, PWM frequency = 1kHz	-5	--	5	
	PWM duty = 1%, I <sub>FBx</sub> = 20mA, PWM frequency = 1kHz	-10	--	10	

## Power-up Procedure

### Suggestion Required Equipments

- RT4539AGQW Evaluation Board
- DC power supply capable of at least 30V and 4A
- DC power supply capable of at least 6V and 1A
- Function Generator
- Oscilloscope
- LED Light Bar

### Quick Start Procedures

The Evaluation Board is fully assembled and tested. Follow the steps below to verify board operation. Do not turn on supplies until all connections are made.

**Proper measurement equipment setup and follow the procedure below.**

- 1) With power off, connect the input power supply to VIN and GND pins.
- 2) With power off, connect the input power supply to EN and GND pins.
- 3) With power off, connect the function generator to PWM and GND pins.
- 4) With power off, connect LED light bar to Vout and FB1 to FB6 pins.
- 5) Turn on the power supply at the input.
- 6) Once the proper output voltage is established, adjust the brightness within the operating ranges and observe the FB1 to FB6 current, switching frequency and other performance.

## Detailed Description of Hardware

### Headers Description and Placement

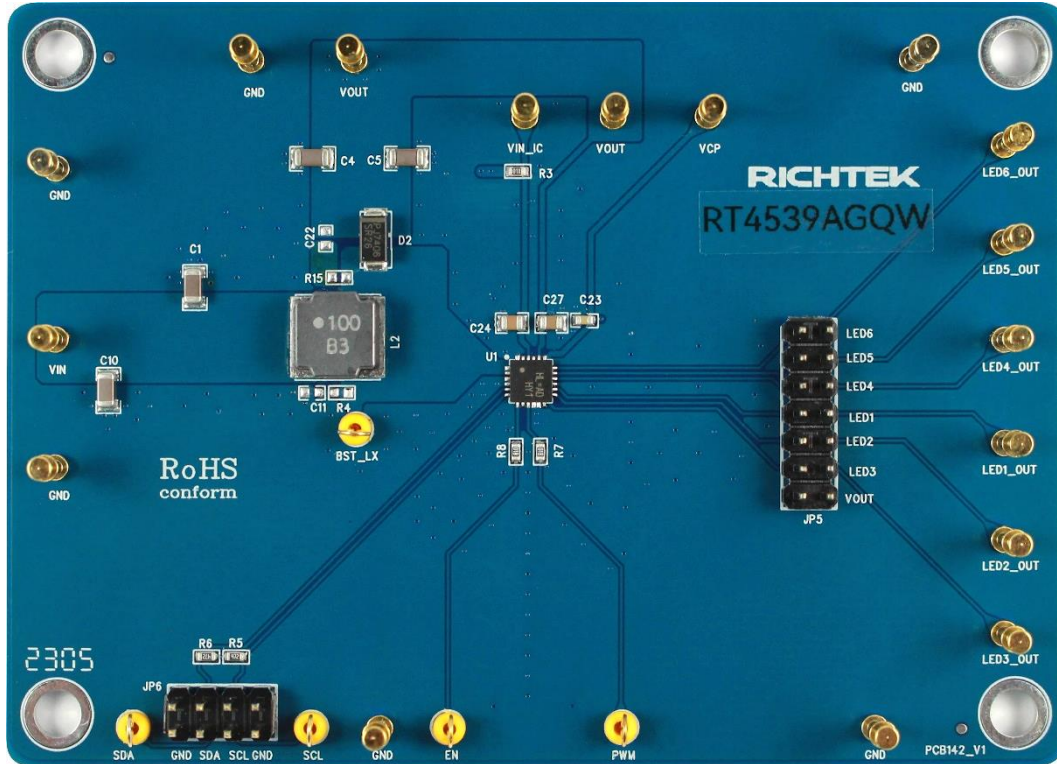

Carefully inspect all the components used in the EVB according to the following Bill of Materials table, and then make sure all the components are undamaged and correctly installed. If there is any missing or damaged component, which may occur during transportation, please contact our distributors or e-mail us at [evb\\_service@richtek.com](mailto:evb_service@richtek.com).

### Test Points

The EVB is provided with the test points and pin names listed in the table below.

Test Point/ Pin Name	Function
<b>LX</b>	Switch node of boost converter.
<b>PGND</b>	Power ground.
<b>SDA</b>	Data signal input of I <sup>2</sup> C interface.
<b>SCL</b>	Clock signal input of I <sup>2</sup> C interface.
<b>PWM</b>	PWM dimming control input.
<b>EN</b>	Enable control input (active high).
<b>VIN</b>	Device power supply input.
<b>VOUT</b>	Output of boost converter.

Test Point/ Pin Name	Function
<b>VCP</b>	Internal LDO output pin. Connect a capacitor (Ccp) between this pin and the ground reference.
<b>FB1</b>	Current sink for LED1.
<b>FB2</b>	Current sink for LED2.
<b>FB3</b>	Current sink for LED3.
<b>FB4</b>	Current sink for LED4.
<b>FB5</b>	Current sink for LED5.
<b>FB6</b>	Current sink for LED6.

**Bill of Materials**

VIN = 3.8V, EN = 3.3V, fsw = 600kHz, ILED <sup>max</sup> = 20mA/Ch						
Reference	Count	Part Number	Value	Description	Package	Manufacturer
U1	1	RT4539AGQW	RT4539AGQW	LED Driver	WQFN-24L 4x4	RICHTEK
C1, C10	2	GRM31CR71H475KA12L	4.7μF	Capacitor, Ceramic, 50V, X7R	1206	MURATA
C4, C5	2	UMK316BJ225KD-T	2.2μF	Capacitor, Ceramic, 50V, X5R	1206	TAIYO YUDEN
C23	1	0603X105K250CT	1μF	Capacitor, Ceramic, 16V, X7R	0603	WALSIN
C24, C27	2	GRM21BR71H105KA12L	1μF	Capacitor, Ceramic, 50V, X7R	0805	MURATA
D2	1	SR26	SR26	SR26	SMA/DO-214AC	PANJIT
L2	1	LSXNH8080YKL100MJG	10μH	10μH	L-8x8	TAIYO YUDEN
R3	1	WR06X10R0FTL	10	10	0603	WALSIN
R5, R6	2	RTT034701FTP	4.7k	4.7k	0603	RALEC
R7, R8	2	RTT031001FTP	1k	1k	0603	RALEC

**Typical Applications**

**EVB Schematic Diagram**

**Boost, Max. OC=3A**

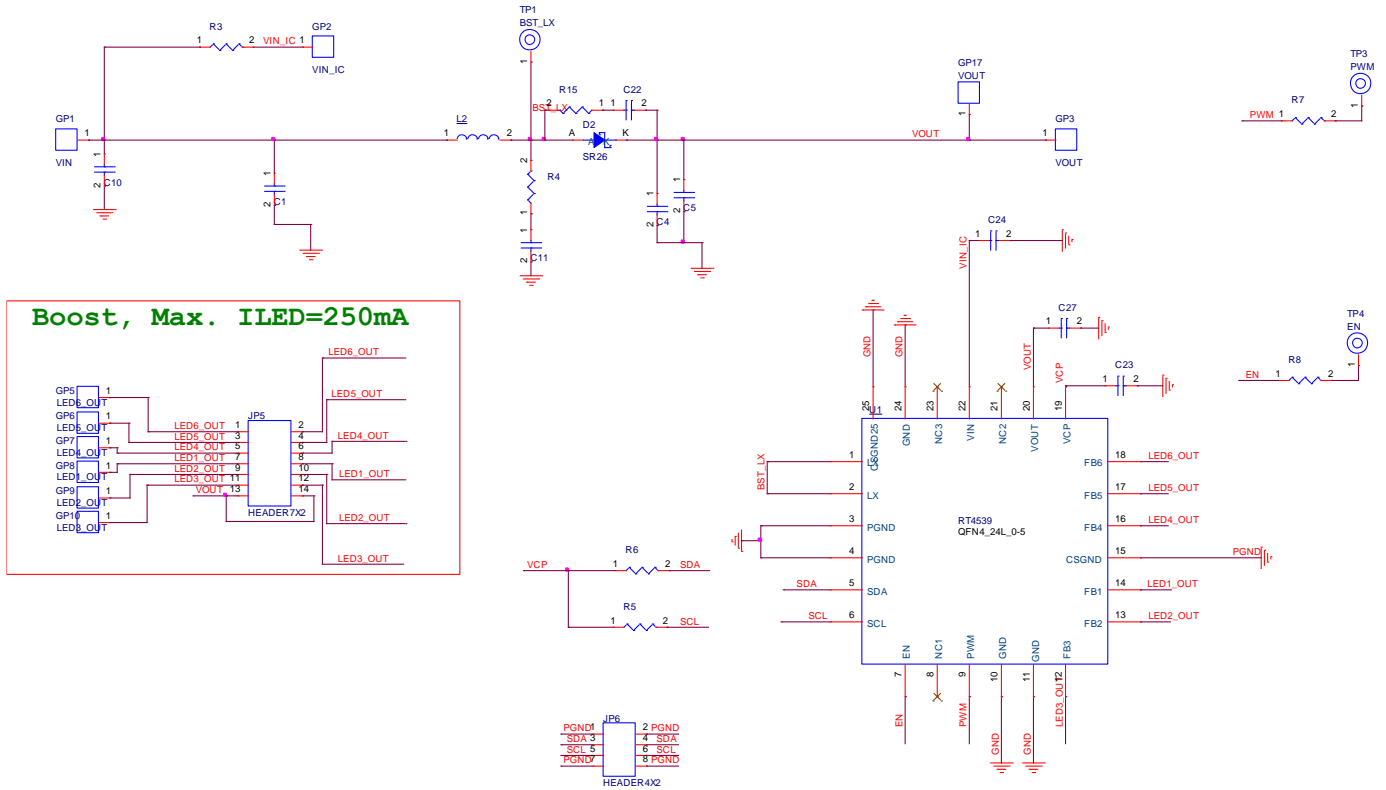

**Measure Result**

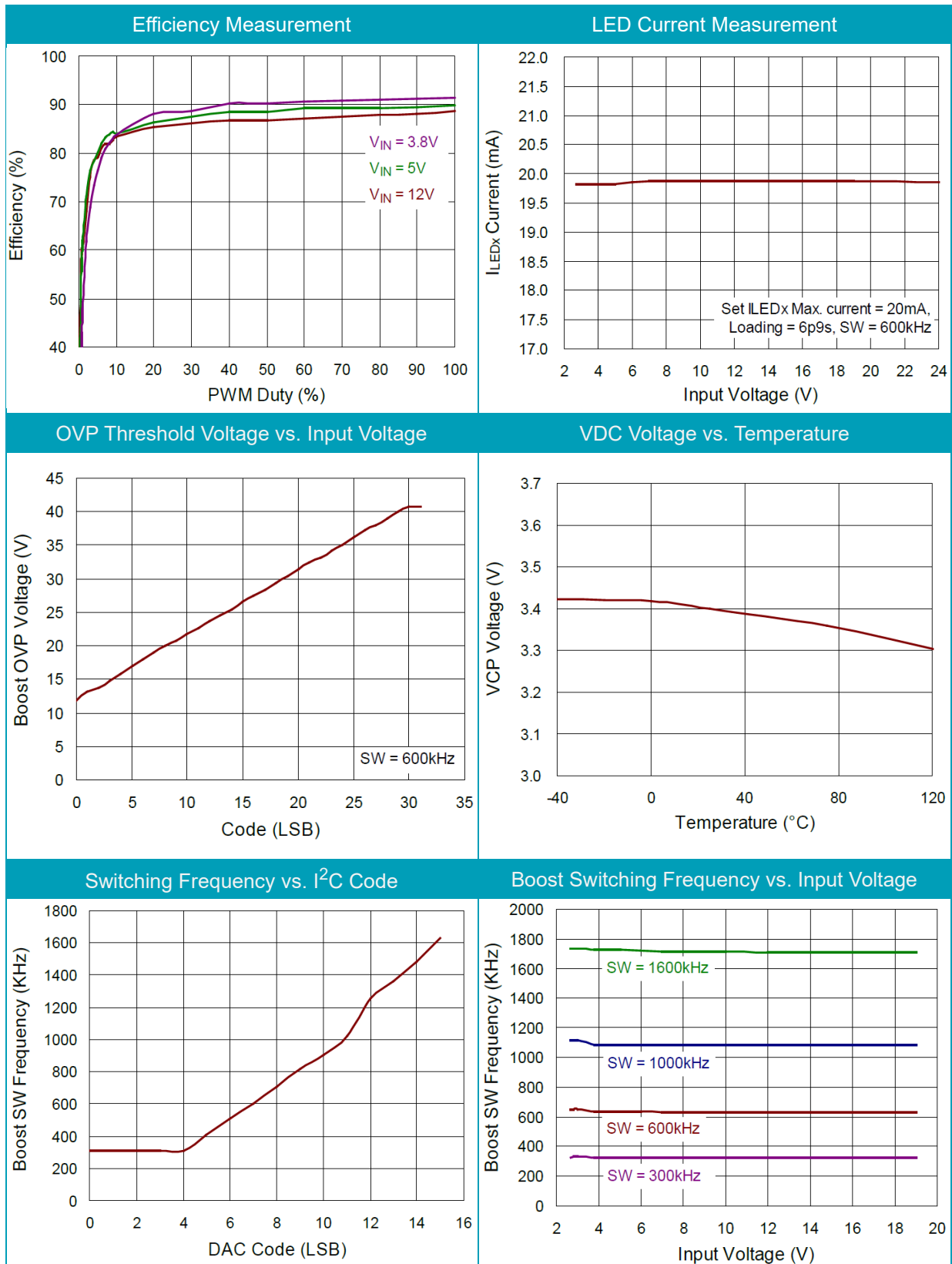





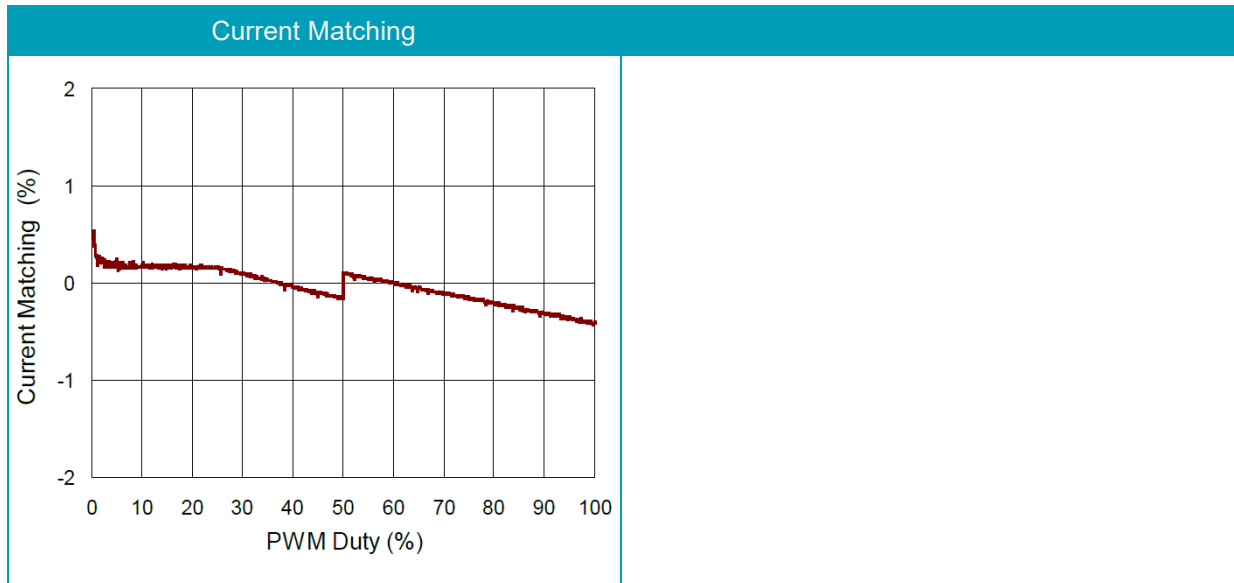

**Evaluation Board Layout**

Figure 1 to Figure 4 are RT4539AGQW Evaluation Board layout. This board size is 75mm x 70mm and is constructed on four-layer PCB, outer layers with 1 oz. Cu and inner layers with 1 oz. Cu.

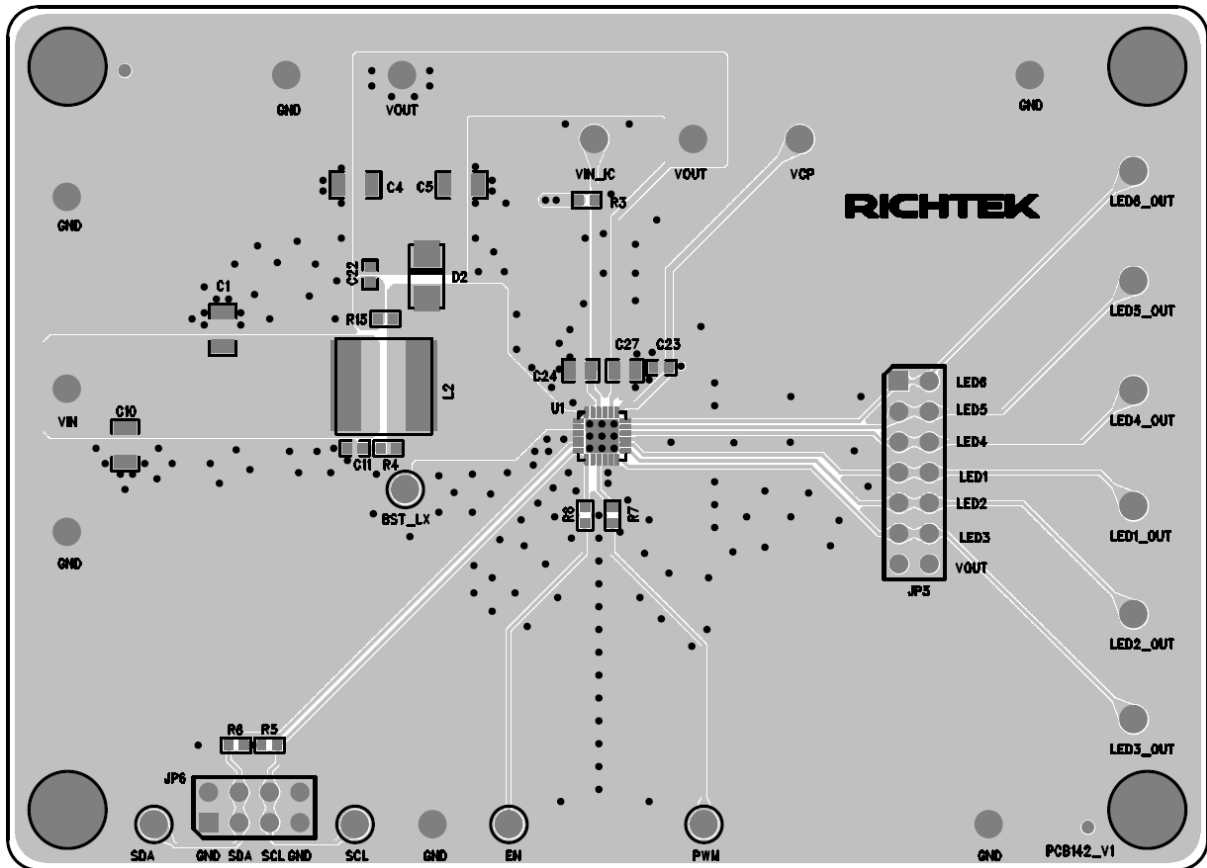

Figure 1. Top View (1<sup>st</sup> layer)

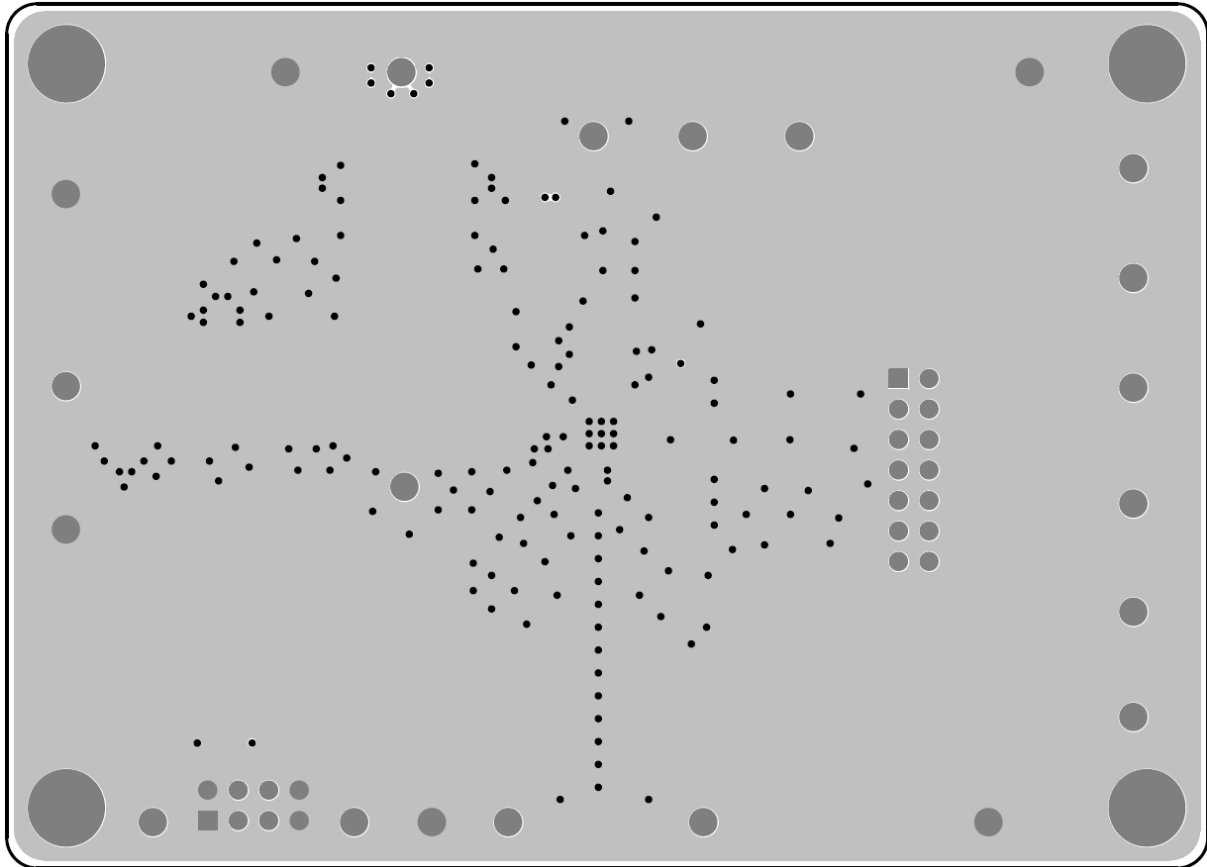

Figure 2. PCB Layout—Inner Side (2<sup>nd</sup> Layer)

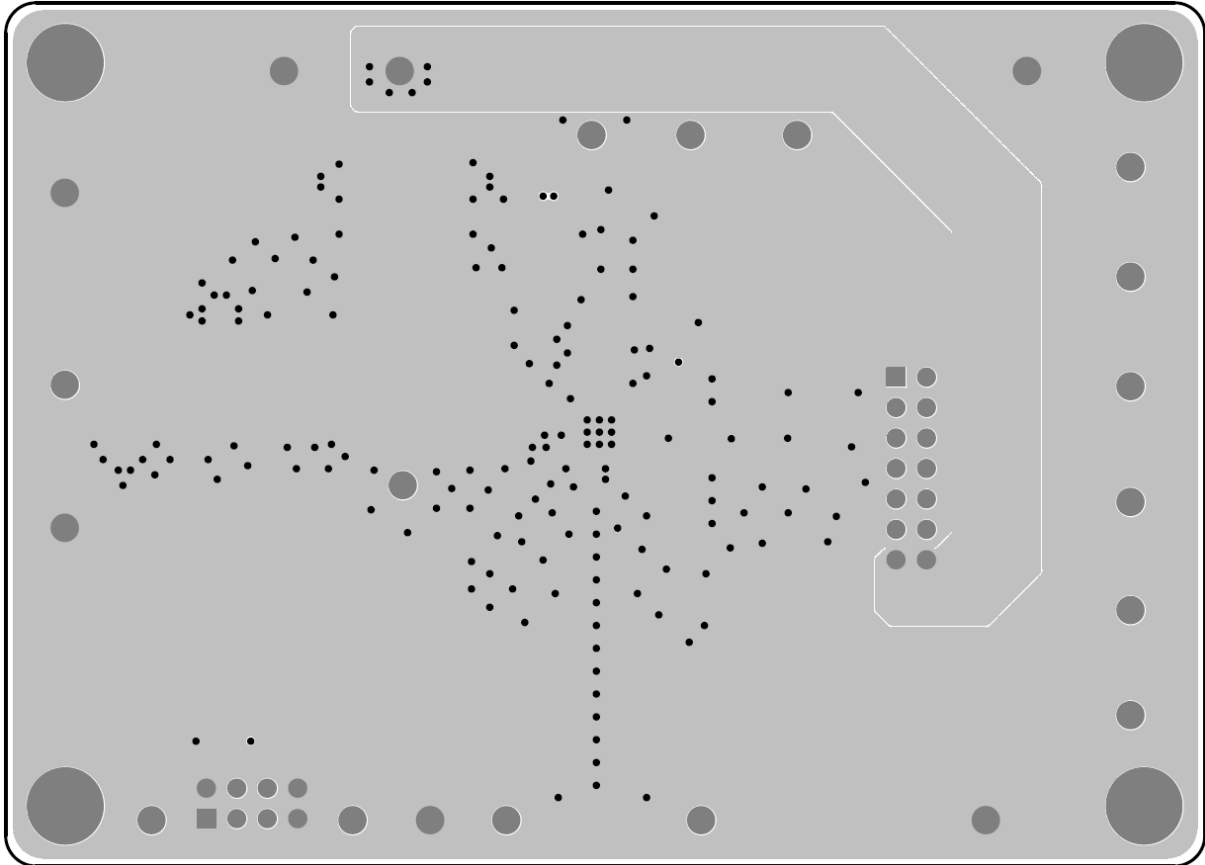

Figure 3. PCB Layout—Inner Side (3<sup>rd</sup> Layer)

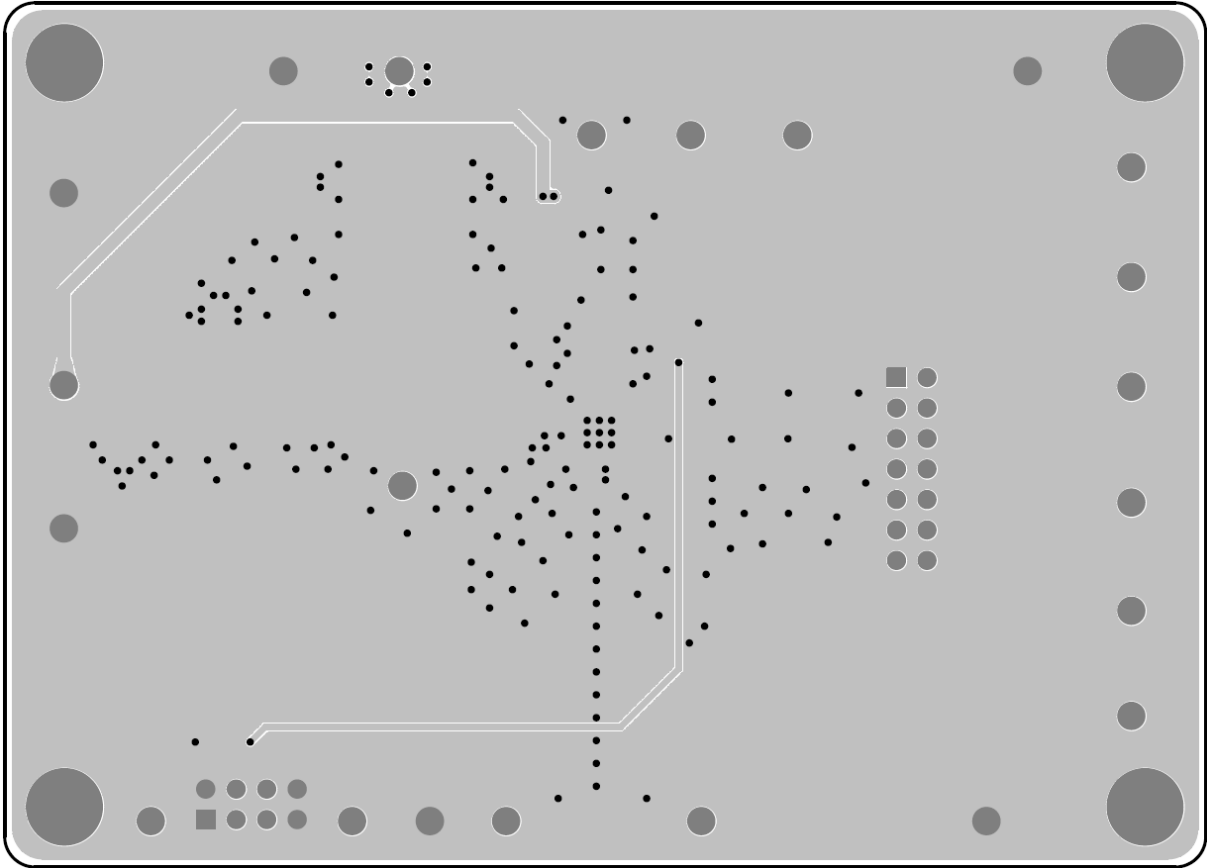

Figure 4. Bottom View (4<sup>th</sup> Layer)

## ***More Information***

For more information, please find the related datasheet or application notes from Richtek website  
<http://www.richtek.com>.

## ***Important Notice for Richtek Evaluation Board***

THIS DOCUMENT IS FOR REFERENCE ONLY, NOTHING CONTAINED IN THIS DOCUMENT SHALL BE CONSTRUED AS RICHTEK'S WARRANTY, EXPRESS OR IMPLIED, UNDER CONTRACT, TORT OR STATUTORY, WITH RESPECT TO THE PRESENTATION HEREIN. IN NO EVENT SHALL RICHTEK BE LIABLE TO BUYER OR USER FOR ANY AND ALL DAMAGES INCLUDING WITHOUT LIMITATION TO DIRECT, INDIRECT, SPECIAL, PUNITIVE OR CONSEQUENTIAL DAMAGES.